

m o o o i<sup>®</sup>



## Something Like This Sofa

---

by Maarten Baas

The Something Like This Sofa is a celebration of the designer's love for sketchy drawings translated into a soft, unusually modelled sofa.

[Click to configure the \*Something Like This\* sofa yourself](#)

---

**Designer**  
**Year of design**

Maarten Baas  
2017

## Dimensions chaise longue left

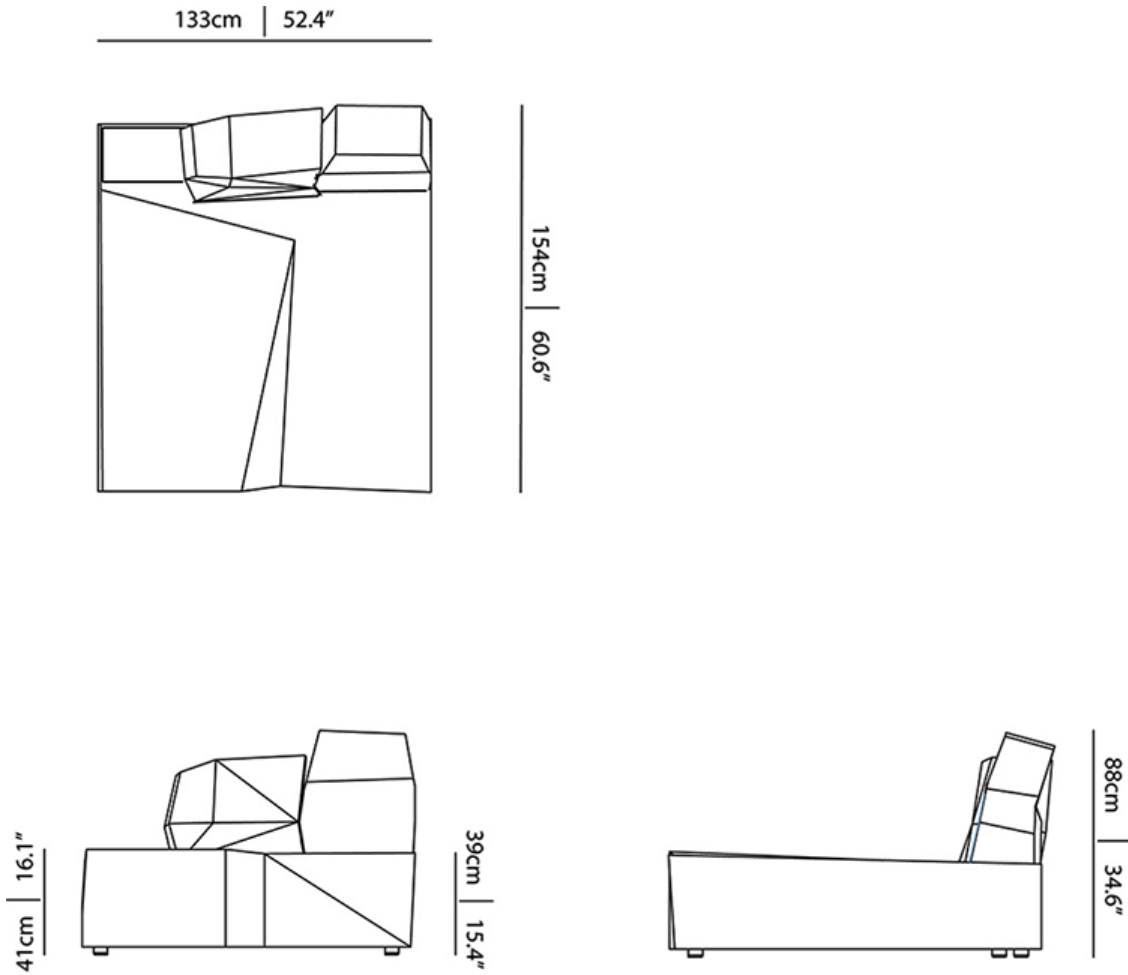

## Dimensions chaise longue right

# m o o o i<sup>®</sup>

132cm | 52"

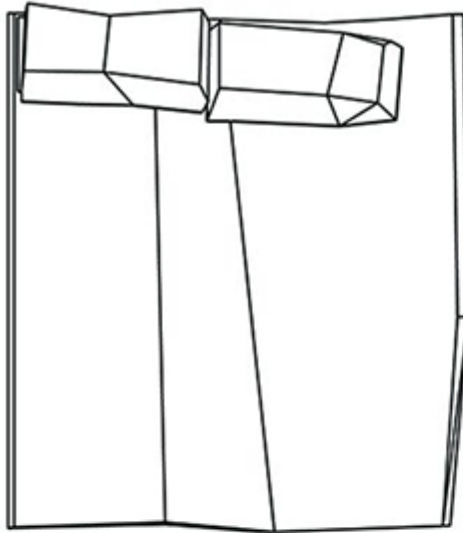

152cm | 59.8"

39cm | 15.4"

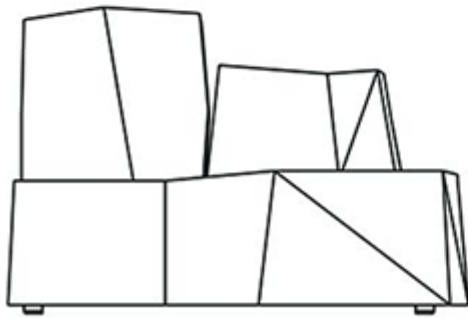

41cm | 16.1"

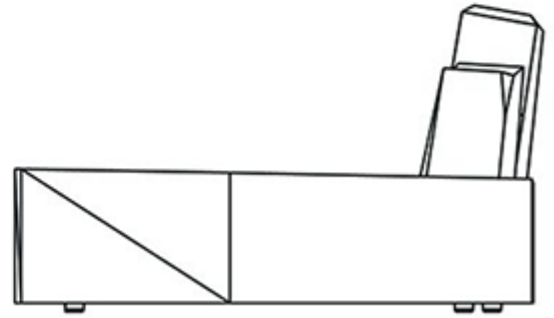

88cm | 34.6"

116cm | 45.7"

## Dimensions double seat

# m o o o i<sup>®</sup>

142cm | 55.9"

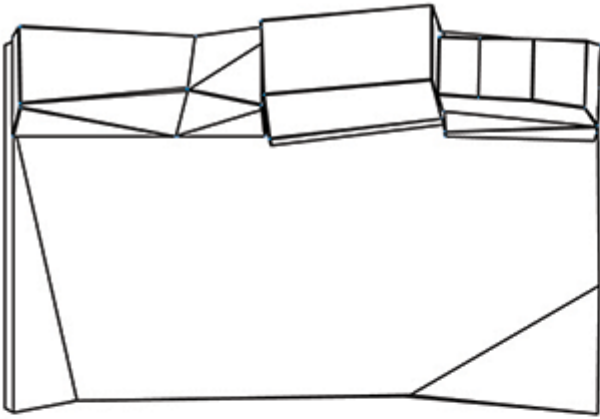

97cm | 38.2"

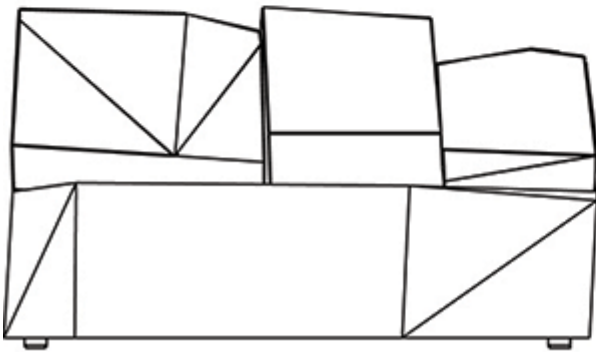

39cm | 15.4"

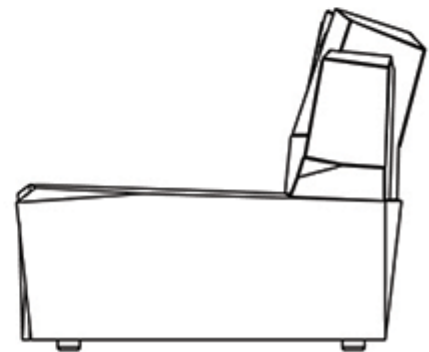

81cm | 31.9"

64cm | 25.2"

## Abbracci

# m o o o i<sup>®</sup>

## composition

100% pl

## abrasion

50.000 martindale

## lightfastness 4

## firetest

FR BS5852 0/1

EN1021 I&2



Abbracci  
**Black**

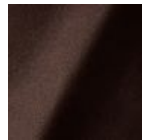

Abbracci  
**Brown**

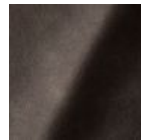

Abbracci  
**Grey**



Abbracci  
**Oyster**

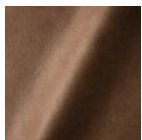

Abbracci  
**Taupe**

---

## Solis

## composition

2% PA 3% PC 30% PL 65% WO

## abrasion

40.000 Martindale rubs, EN ISO 12947

## lightfastness

Note 5, EN ISO 105-B02

## firetest

EN 1021-1/2

US. Cal. Bull. 117-2013

Upon request, with treatment:

BS5852 part I

BS5852 crib5



Solis  
**Crust**



Solis  
**Dawn**



Solis  
**Fog**



Solis  
**Gray**



Solis  
**Paper**

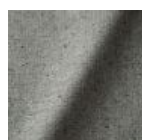

Solis  
**Rain**



Solis  
**Spencer**



Solis  
**Suit**



Solis  
**Sunset**

## Justo

### composition

15% CO, 35% PC, 10% PL, 40% VI

### abrasion

50.000 Martindale rubs, EN ISO 12947

### lightfastness

Note 5, EN ISO 105-B02

### fire test

EN 1021-1/2

US. Cal. Bull. 117-2013

NFPA 260

Upon request, with treatment:

BS5852 part 1

BS5852 crib 5

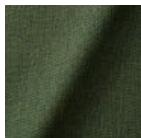

Justo  
**Alge**

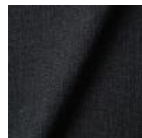

Justo  
**Basalt**

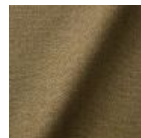

Justo  
**Bred**

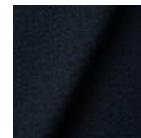

Justo  
**Flod**

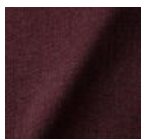

Justo  
**Hinde**

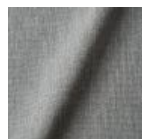

Justo  
**Lyse**



Justo  
**Muse**

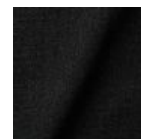

Justo  
**Nat**

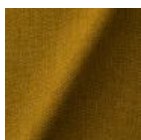

Justo  
**Sennep**

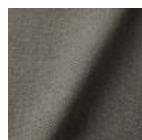

Justo  
**Sten**

## Liscio

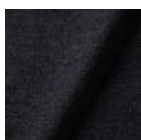

Liscio  
**Grigio Blu  
Scuro**

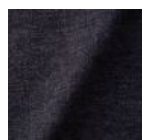

Liscio  
**Grigio Blu**

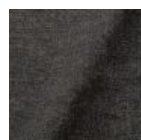

Liscio  
**Grigio Scuro**

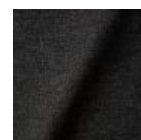

Liscio  
**Muscio Scuro**



Liscio  
**Muscio**



Liscio  
**Argento**



**Liscio**  
Nebbia

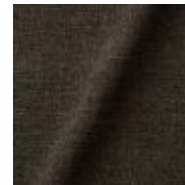

Liscio  
**Pietra**



Liscio  
**Perla**



Liscio  
**Latte Scuro**



Liscio  
**Latte**

## Vesper

### composition

10% CO, 40% L, 10% PA, 10% PL, 30% VI

### abrasion

40.000 Martindale rubs, EN ISO 12947

### lightfastness

Note 5, EN ISO 105-B02

### firetest

EN 1021-1/2

US. Cal. Bull. 117-2013

Upon request, with treatment:

BS5852 part I

BS5852 crib5



Vesper  
**Aluminium**

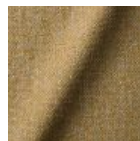

Vesper  
**Brass**

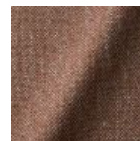

Vesper  
**Bronze**



Vesper  
**Carbon**



Vesper  
**Nickel**



Vesper  
**Silver**

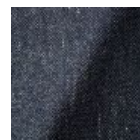

Vesper  
**Steel**



Vesper  
**Titan**

## Twill

# m o o o i<sup>®</sup>

## composition

72% wo, 8% pa, 20% pl

## abrasion

75.000 martindale

## lightfastness 5

## firetest

EN1021 I&2



Twill  
**Caviar**

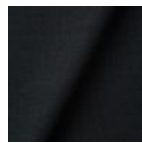

Twill  
**Graphite**

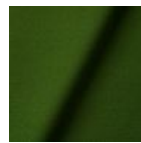

Twill  
**Grass**



Twill  
**Grey**



Twill  
**Linen**

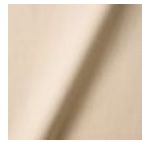

Twill  
**Natural**

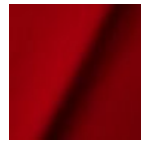

Twill  
**Passion**

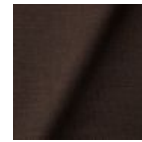

Twill  
**Walnut**

---

## Twill Melange

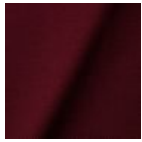

Twill Melange  
**Chili**



Twill Melange  
**Dust**

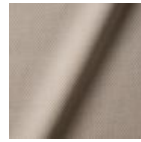

Twill Melange  
**Flour**



Twill Melange  
**Lagoon**



Twill Melange  
**Lavender**

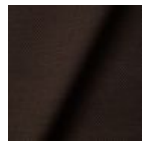

Twill Melange  
**Peat**

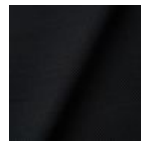

Twill Melange  
**Slate**



Twill Melange  
**Twig**

---

## Plush

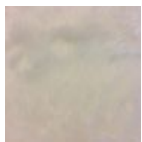

white

---

## Cervino Leather



# m o o o i<sup>®</sup>

## **composition**

100% aniline leather

Leather is a natural product, colours may vary from hide to hide.

## **firetest**

EN1021 I&2

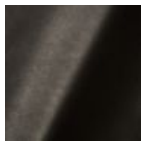

Cervino Leather  
**Anthracite**

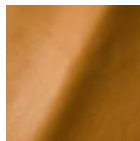

Cervino Leather  
**Cognac**



Cervino Leather  
**Mud**

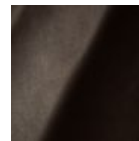

Cervino Leather  
**Pure**